



KONICA MINOLTA

NEW Spectrophotometer

CM-26dG

CM-26d

CM-25d



Advanced performance
for the times.

Easy operation
for front-line use.

Highest level of repeatability with high inter-instrument agreement, incomparable speed, and high usability.

The CM-26dG Series from Konica Minolta offers three variations of advanced portable spectrophotometers.

The high-end CM-26dG and CM-26d models bring the industry's highest level of accuracy, with the CM-26dG capable of simultaneously measuring color and gloss, and the CM-26d specifically for measuring color.

The lineup is rounded out with the high cost-performance model, the CM-25d.

NEW Spectrophotometer

CM-26dG | CM-26d | CM-25d



■ **2-in-1 instrument for measuring color and gloss**

The CM-26dG performs the job of two instruments by simultaneously measuring color and gloss. Because color and gloss measurements can be done with a single device, separate spectrophotometers and glossmeters do not need to be prepared and switched in and out, which instantly improves work efficiency especially when measuring a large quantity of samples.

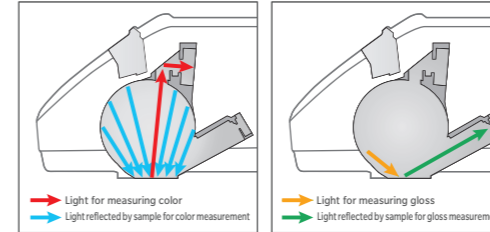

■ **Incomparable speed**

The CM-26dG measures color in about half the time required of previous models, at approx. 0.7 sec (SCI or SCE). Moreover, it takes about 1 sec to measure both color and gloss (SCI or SCE + Gloss). The faster measuring speed translates into higher work efficiency.

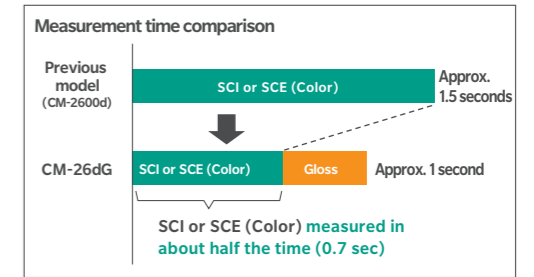

(Actual size)

■ **Highest levels of repeatability and inter-instrument agreement amongst portable spectrophotometers**

Because of the way supply chains are constantly being built and modified, data needs to be shared amongst increasingly more sites. This has made high repeatability and high inter-instrument agreement prerequisites for portable spectrophotometers. The CM-26dG and CM-26d realize the highest level of inter-instrument agreement amongst currently available portable spectrophotometers, at ΔE^*ab 0.12 (BCRA average amongst 12 colors). And when measuring gloss, inter-instrument agreement of the CM-26dG is within ± 0.2 GU (0-10 GU) or ± 0.5 GU (10-100 GU). Moreover, repeatability is half that of predecessor models, at $\sigma \Delta E^*ab$ 0.02. The contribution to digital color data management that this level of performance offers will help manufacturers enhance quality management between their factories and suppliers.

<Quick and easy-to-use Spectrophotometer Configuration Tool CM-CT1>

The CM-CT1 gives manufacturers the means for easily and quickly setting up their CM-26dG Series spectrophotometers. Moreover, when multiple devices are used or when the same conditions need to be set amongst multiple factories or suppliers, settings can be compiled into a file and shared.

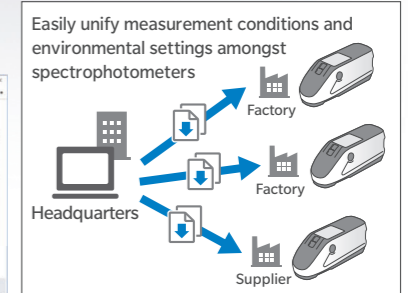

Spectrophotometer Configuration Tool CM-CT1 ●OS : Windows® 7 32 bit, 64 bit / Windows® 8.1 32 bit, 64 bit / Windows® 10 32 bit, 64 bit
 ●CPU: 2 GHz equivalent or faster ●Memory: 2 GB or more ●Hard disk: 10 GB or more of free space for installation ●Display: Resolution: 1,024 x 720 dots or more/ 16-bit colors or more ●Other: USB port (For connecting to spectrophotometers)
 •Windows® is a trademark or registered trademark of Microsoft Corporation in the USA and other countries.

Highest level of repeatability with high inter-instrument agreement, incomparable speed, and high usability.

The CM-26dG Series from Konica Minolta offers three variations of advanced portable spectrophotometers.

The high-end CM-26dG and CM-26d models bring the industry's highest level of accuracy, with the CM-26dG capable of simultaneously measuring color and gloss, and the CM-26d specifically for measuring color.

The lineup is rounded out with the high cost-performance model, the CM-25d.

NEW Spectrophotometer

CM-26dG | CM-26d | CM-25d



■ **Viewfinder**

The viewfinder brightly illuminates the measurement point with an LED to make target alignment faster, easier and more precise. It also incorporates a pointer that makes it even easier to identify the measurement area. Moreover, because it allows the user to look down from above the spectrophotometer, the viewfinder is perfect for setting measurement points on patterns and prints.



■ **Compact, lightweight streamlined body**

Designed to work in hard-to-reach places, the CM-26dG Series spectrophotometers allow users to take measurements where previous models could not. The nose is angled downward and rounded at the corners to get into cramped spots like dashboards at a point near the windshield. Moreover, the plastic target mask lessens the risks of scratching the sample. And there is a trigger button on both sides so that measurements can be taken stress-free in any sort of situation, no matter which hand you use.



JOB function execution screen

(Actual size)

■ **High usability and functional versatility**

<JOB Function>

Instructions (including photos) for often-used workflows can be registered using SpectraMagic NX (Ver. 2.9 or later, sold separately).

<Bluetooth® ready>

Data can be wirelessly transmitted to computers or other paired devices over a Bluetooth connection.

Color Data Software SpectraMagic NX

SpectraMagic NX is color management software that gives users a plethora of functions for viewing, operating and controlling their spectrophotometers from a computer. Users can create their own windows by arranging and editing spectral graphs, color difference graphs (2D, 3D), OK/NG indications and other objects to suit their needs.

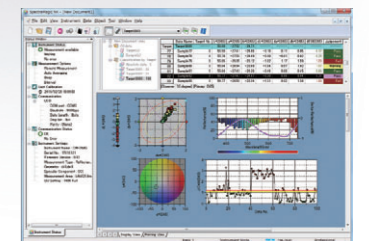

SpectraMagic NX Ver. 2.9 or later ●OS : Windows® 7 Professional 32 bit, 64 bit / Windows® 8.1 Pro 32 bit, 64 bit / Windows® 10 Pro 32 bit, 64 bit

* The computer must be running one of the above OS and meet or exceed the below specifications.

●CPU: Pentium® III 600 MHz equivalent or faster ●Memory:128 MB or more (256 MB or more recommended) ●Hard disk: 450 MB or more of free space for installation ●Display: Resolution: 1,024 x 768 dots or more/ 16-bit colors or more ●Other: DVD-ROM drive (for software installation), USB port (for entering the protection key), USB or serial port (for connecting to spectrophotometers) and Internet Explorer Ver. 5.01 or later installed

•Windows® is a trademark or registered trademark of Microsoft Corporation in the USA and other countries. •Pentium® is a trademark or registered trademark of Intel Corporation in the USA and other countries.

■ **CM-26dG Series spectrophotometers can be used in a wide range of fields.**

Automotive interiors, ICT products, Home appliances, Paint, Ceramics, Plastics, Solar panels, Glass, etc.

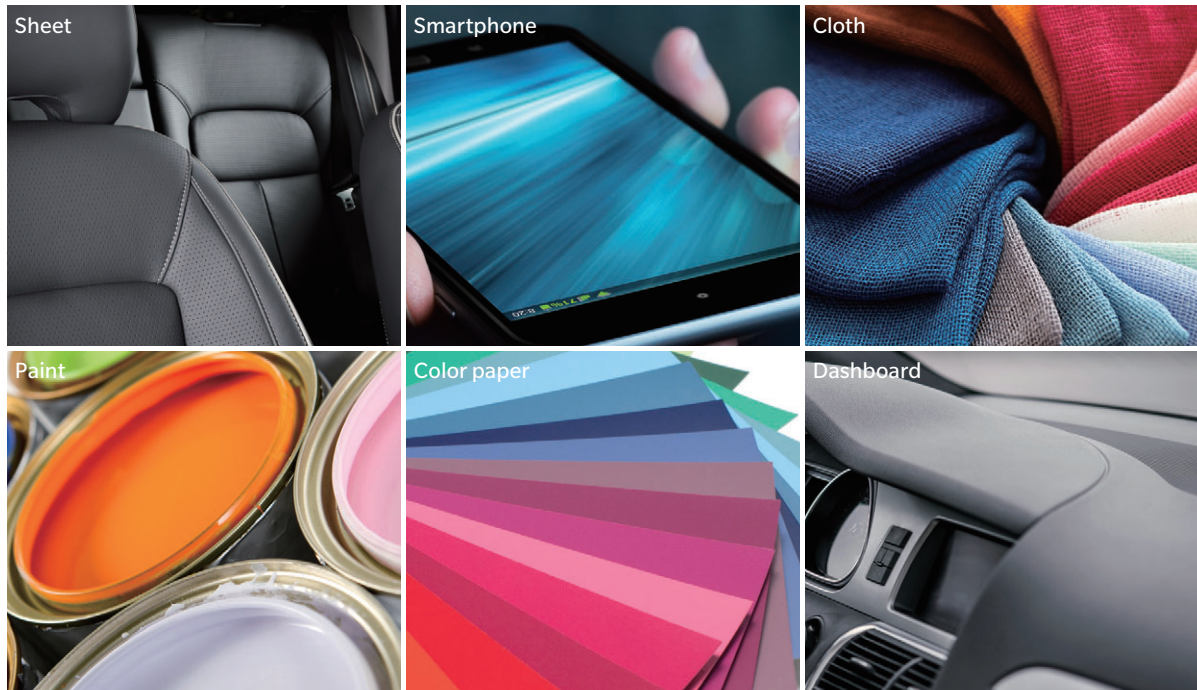

■ **Performance by model**

	CM-26dG	CM-26d	CM-25d
SCI	●	●	●
SCE	●	●	●
60° gloss	●	—	—
MAV	●	●	●
SAV	●	●	—
UV 0% /100%	●	●	—
Inter-instrument agreement (Color)	<0.12	<0.12	<0.20
Repeatability ($\sigma\Delta E^*ab$)	<0.02	<0.02	<0.04
Wavelength range	360 - 740 nm	360 - 740 nm	400 - 700 nm



Stapler Type Target Mask CM-A268



Target Mask (MAV; w/ glass) CM-A277

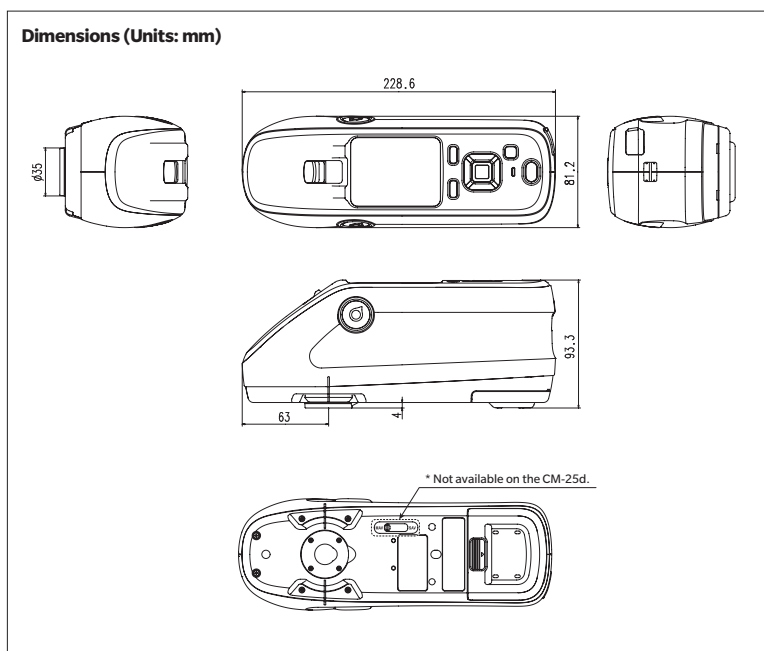

•KONICA MINOLTA, the Konica Minolta logo and symbol mark, "Giving Shape to Ideas" and SpectraMagic™ are registered trademarks or trademarks of KONICA MINOLTA, INC. •Bluetooth® is a registered trademark of Bluetooth SIG, Inc. and is used under license agreement. •Displays shown are for illustration purposes only. •The specifications and appearance shown herein are subject to change without notice.

Specifications

Model	CM-26dG	CM-26d	CM-25d
Color	Illumination/viewing system: di: 8°, de: 8° (diffuse illumination: 8° viewing) SCI (specular component included) / SCE (specular component excluded) switchable Integrating sphere: Ø54 mm Light source: Pulsed xenon lamp × 2 Detector: Dual 40-element silicon photodiode arrays Spectral separation device: Planar diffraction grating Measurement wavelength range: 360 to 740 nm Measurement wavelength pitch: 10 nm Half bandwidth: Approx. 10 nm Reflectance measurement range: 0 to 175%; Display resolution: 0.01 Illumination area: 12 × 12.5 mm (circle + ellipse) MAV: Ø12 mm SAV: Ø6 mm Measurement area: MAV: Ø8 mm, SAV: Ø3 mm Repeatability: Standard deviation within ΔE*ab 0.02 (When a white calibration plate is measured 30 times at 5-second intervals after white calibration) Inter-instrument agreement: Within ΔE*ab 0.12 (Based on average for 12 BCRA Series II color tiles; MAV SCI; compared to values measured with a master body under KONICA MINOLTA standard measurement conditions) UV adjustment: UV 100% / UV 0% Observer: 2° observer angle, 10° observer angle Illuminant: A, C, D50, D65, F2, F6, F7, F8, F10, F11, F12, ID50, ID65, User-defined illuminant*1 (Simultaneous evaluation with two light sources possible) Display items: Colorimetric values/graph, color difference values/graph, spectral graph, pass/fail judgment, pseudocolor Colorimetric values: L*a*b*, L*C*h, Hunter Lab, Yxy, XYZ, and color difference in these spaces; Munsell (C) Indexes: MI, WI (ASTM E313-73), YI (ASTM E313-73, ASTM D1925), ISO brightness (ISO 2470), WI/Tint (CIE), Strength, Opacity, Grey scale, 8° gloss value, User index*1 Color difference equations: ΔE*ab (CIE1976) / ΔE94 (CIE1994) / ΔE00 (CIE2000) / CMC (l:c) / Hunter ΔE / DIN99a Applicable standards: DIN 5033 Teil 7, JIS Z 8722 Condition "c", ISO 7724/1, CIE No. 15		
Gloss	Measurement angle: 60°		
	Light source: White LED		
	Detector: Silicon photodiode		
	Measurement range: 0 to 200 GU; Display resolution: 0.01 GU		
	Measurement area: MAV: 10 × 7 mm, SAV: Ø3 mm		
	Repeatability: Standard deviation 0 to 9.99 GU: Within 0.1 GU 10 to 99.99 GU: Within 0.2 GU 100 to 200 GU: Within 0.2% of indicated value (When measured 30 times at 5-second intervals after calibration)		
	Inter-instrument agreement: 0 to 9.99 GU: Within ±0.2 GU 10 to 99.99 GU: Within ±0.5 GU (MAV; compared to values measured with a master body under KONICA MINOLTA standard measurement conditions)		
	Applicable standards: JIS Z8741 (MAV only), JIS K5600, ISO 2813, ISO 7668 (MAV only), ASTM D523-08, ASTM D2457-13, DIN 67530		
	Measurement time: Approx. 1 sec. (Measurement mode: SCI + Gloss or SCE + Gloss) (From pressing trigger button to measurement completion)	Approx. 0.7 sec. (Measurement mode: SCI or SCE)	
	Minimum measurement interval: Approx. 2 sec (Measurement mode: SCI + gloss or SCE + gloss)	Approx. 1.5 sec (Measurement mode: SCI or SCE)	
Data memory: 1,000 target data + 5,100 sample data			
Battery performance: Measurement mode: SCI + Gloss or SCE + Gloss	Measurement mode: SCI or SCE		
Viewfinder function: Available (with white LED illumination)			
Display: 2.7" color TFT-LCD with reversible portrait viewing mode			
Display language: English, Japanese, German, French, Italian, Spanish, Simplified Chinese, Portuguese, Russian, Turkish, Polish			
Interface: USB 2.0; Bluetooth (SPP-compatible. Optional Bluetooth module required)			
Power: Dedicated lithium-ion battery (removable), USB bus power (with lithium-ion battery installed), Dedicated AC adapter (with lithium-ion battery installed)			
Charging time: Approx. 6 h			
Operating temperature/humidity range: Temperature: 5 to 40°C, Relative humidity: 80% or less (at 35°C) with no condensation			
Storage temperature/humidity range: Temperature: 0 to 45°C, Relative humidity: 80% or less (at 35°C) with no condensation			
Size: Approx. 81 (W) × 93 (H) × 229 (D) mm			
Weight: Approx. 660 g	Approx. 630 g	Approx. 620 g	

*1 Optional Color Management Software SpectraMagic NX is required for setting user-configured illuminants or user indexes.

System Diagram

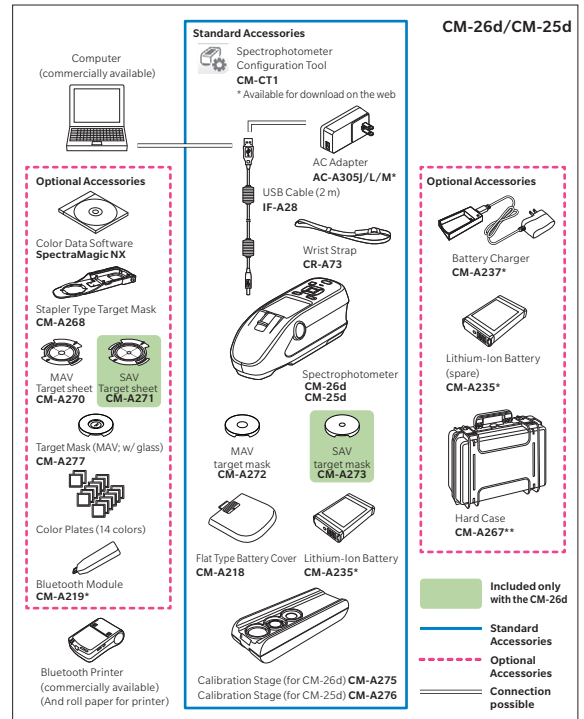
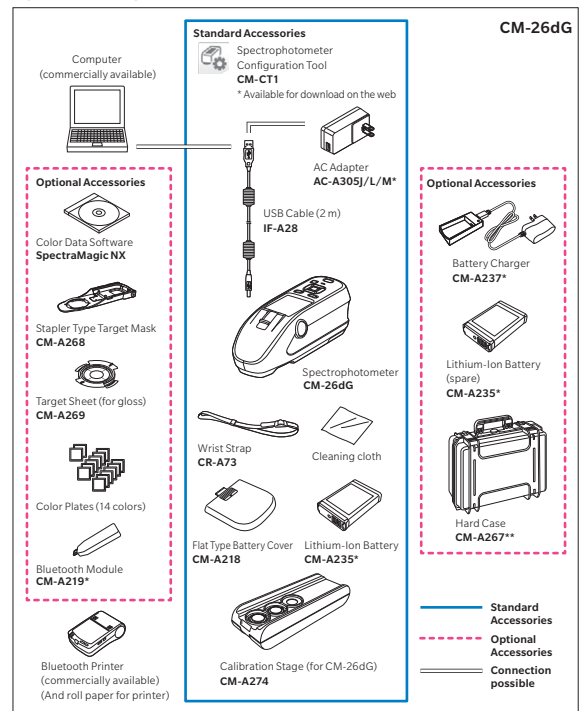

* Depending on the location, some accessories may not be available.
** May be included as a standard accessory in some regions.

SAFETY PRECAUTIONS

For correct use and for your safety, be sure to read the instruction manual before using the instrument.

- Always connect the instrument to the specified power supply voltage. Improper connection may cause a fire or electric shock.

ISO Certifications of KONICA MINOLTA, Inc., Sakai Site

ISO 9001

JQA-QMA1588

Design, development, manufacture/
manufacturing management, calibration, and
service of measuring instruments

ISO 14001

JQA-E-80027

Design, development,
manufacture, service and sales
of measuring instruments

KONICA MINOLTA, INC.
Konica Minolta Sensing Americas, Inc.
Konica Minolta Sensing Europe B.V.

Osaka, Japan
 New Jersey, U.S.A.
 European Headquarter /BENELUX
 German Office
 French Office
 UK Office
 Italian Office
 Swiss Office
 Nordic Office
 Polish Office
 Turkish Office
 SE Sales Division
 Beijing Office
 Guangzhou Office
 Chongqing Office
 Qingdao Office
 Wuhan Office

Phone : 888-473-2656 (in USA), 201-236-4300 (outside USA)
Phone : +31 (0) 30 248-1193
Phone : +49 (0) 89 4357 156 0
Phone : +33 (0) 1 80 11 10 70
Phone : +44 (0) 1925 467300
Phone : +39 02849488.00
Phone : +41 (0) 43 322-9800
Phone : +46 (0) 31 7099464
Phone : +48 (0) 71 73452-11
Phone : +90 (0) 216-528 56 56
Phone : +86- (0)21-5489 0202
Phone : +86- (0)10-8522 1551
Phone : +86- (0)20-3826 4220
Phone : +86- (0)23-6773 4988
Phone : +86- (0)532-8079 1871
Phone : +86- (0)27-8544 9942
Phone : +65 6563-5533
Phone : +82 (0) 2-523-9726

Phone : +31 (0) 30 24 81 211
Phone : +43 (0) 1 80 11 10 82
Phone : +44 (0) 1925 711143
Phone : +39 02849488.30
Phone : +41 (0) 43 322-9809
Phone : +48 (0) 71 734 52 10
Phone : +90 (0) 212-253 49 69
Phone : +86- (0)21-5489 0005
Phone : +86- (0)10-8522 1241
Phone : +86- (0)20-3826 4223
Phone : +86- (0)23-6773 4799
Phone : +86- (0)532-8079 1873
Phone : +86- (0)27-8544 9991
Phone : +65 6560-9721
Phone : +82 (0) 31-995-6511

Fax : 201-785-2482
Fax : +31 (0) 30 24 81 211
Fax : +49 (0) 89 4357 156 99
Fax : +33 (0) 1 80 11 10 82
Fax : +44 (0) 1925 711143
Fax : +39 02849488.30
Fax : +41 (0) 43 322-9809
Fax : +48 (0) 71 734 52 10
Fax : +90 (0) 212-253 49 69
Fax : +86- (0)21-5489 0005
Fax : +86- (0)10-8522 1241
Fax : +86- (0)20-3826 4223
Fax : +86- (0)23-6773 4799
Fax : +86- (0)532-8079 1873
Fax : +86- (0)27-8544 9991
Fax : +65 6560-9721
Fax : +82 (0) 31-995-6511

Konica Minolta (CHINA) Investment Ltd.
Konica Minolta Sensing Singapore Pte Ltd.
Konica Minolta Sensing Korea Co., Ltd.

Addresses and telephone/fax numbers are subject to change without notice. For the latest contact information, please refer to the KONICA MINOLTA Worldwide Offices web page :